

PMC12 SERIES CONNECTOR

The 1/8" flow polypropylene PMC12 offers many of the same configuration options as the PMC. The polypropylene material adds greater chemical resistance and is gamma sterilizable. The PMC12 also mates to small diameter rigid tubing. Available with a 1/4-28 flat bottom port and 1/4-28 UNF threads, these couplings eliminate the need to thread and re-thread common compression nuts each time a tubing connection is made.

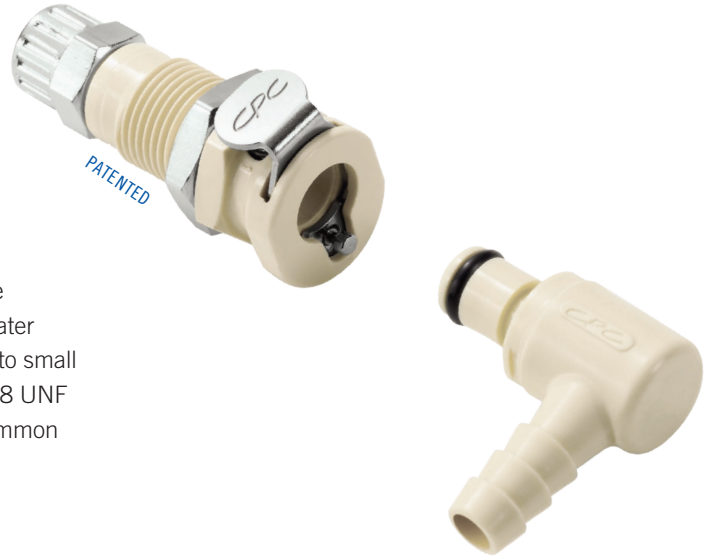

SPECIFICATIONS

PRESSURE:

Vacuum to 120 psi, 8.3 bar

TEMPERATURE:

32°F to 160°F (0°C to 71°C)

MATERIALS:

Main components and valves: Polypropylene

Thumb latch: Stainless steel

Valve spring: 316 stainless steel

External spring and pin: Stainless steel

O-rings: EPDM

STERILIZATION:

Gamma: Up to 50 kGy irradiation

COLOR:

Almond

TUBING SIZES:

Microbore to 1/4" ID, Microbore to 6.4mm ID

WARNING: Pressure, temperature, chemicals, and operating environment can affect the performance of couplings. It is the customer's responsibility to test the suitability of CPC products in their own application conditions.



cpcworldwide.com/PMC12

FEATURES

- Polypropylene material → Chemically resistant and gamma sterilizable
- EPDM o-ring → Greater chemical resistance
- CPC thumb latch → One-hand connection and disconnection
- Integral terminations → Fewer leak points, shorter assemblies, faster installations

BENEFITS

PMC12 AIR FLOW • 100 psig inlet pressure

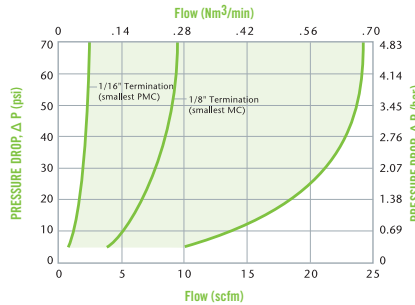

PMC12 Pressure Range

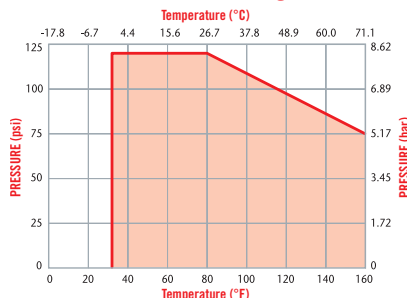

PMC12 WATER FLOW

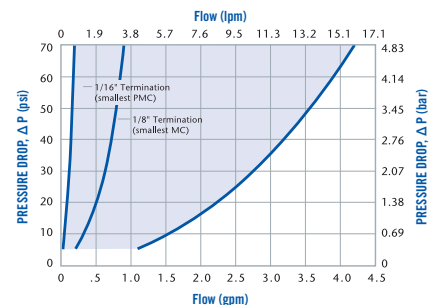

These graphs are intended to give you a general idea of the performance capabilities of each product line. The shaded area of each graph represents the operating range of the product family, i.e., upper and lower values are shown. Therefore, depending on the exact coupling configurations selected, you can reasonably expect values to fall within the shaded area.



CUSTOM PROJECT CAPABILITIES

CPC can develop a solution unique to your needs. Watch our video to learn more...



LIQUID FLOW RATE INFORMATION FOR COUPLINGS

The chart below shows the flow rate for CPC couplings. Each coupling was tested with water at 70°F (21°C). To determine flow rates for specific coupling configurations use the formula to the right.

$$Q = C_v \sqrt{\frac{\Delta P}{S}}$$

- Q = Flow rate in gallons per minute
- C_v = Average coefficient across various flow rates (see chart)
- ΔP = Pressure drop across coupling (psi)
- S = Specific gravity of liquid





C_v VALUES

INSERTS



	BODIES		INSERTS																	
	PMC 200412	PMCD 200412	PMC 200612	PMCD 200612	PMC 220212	PMCD 220212	PMC 220412	PMCD 220412	PMC 240212	PMCD 240212	PMC 240412	PMCD 240412	PMC 230412	PMCD 230412	PMC 210412	PMCD 230412	PMC 220312	PMCD 220312	PMC 220112	PMCD 220112
PMC100212	0.40	0.18	0.50	0.19	0.25	0.16	0.50	0.19	0.50	0.20	0.51	0.19	0.38	0.24	0.30	0.17	0.03	0.03		
PMCD100212	0.27	0.18	0.31	0.18	0.24	0.16	0.28	0.20	0.26	0.20	0.29	0.18	0.27	0.24	0.25	0.17	0.03	0.03		
PMC100412	0.40	0.21	0.50	0.24	0.26	0.18	0.50	0.24	0.50	0.20	0.51	0.24	0.38	0.26	0.30	0.19	0.03	0.03		
PMCD100412	0.29	0.19	0.32	0.23	0.25	0.17	0.30	0.23	0.27	0.21	0.28	0.23	0.29	0.24	0.25	0.18	0.03	0.03		
PMC120412	0.40	0.18	0.50	0.18	0.25	0.16	0.40	0.18	0.40	0.16	0.36	0.18	0.38	0.21	0.30	0.17	0.03	0.03		
PMCD120412	0.21	0.17	0.22	0.17	0.20	0.16	0.22	0.17	0.21	0.17	0.20	0.17	0.21	0.18	0.21	0.16	0.03	0.03		
PMC160212	0.23	0.15	0.28	0.18	0.19	0.14	0.27	0.15	0.27	0.15	0.28	0.18	0.23	0.16	0.20	0.14	0.03	0.03		
PMCD160212	0.19	0.15	0.19	0.15	0.17	0.14	0.19	0.15	0.18	0.15	0.18	0.15	0.19	0.15	0.18	0.14	0.03	0.03		
PMC160412	0.33	0.23	0.44	0.24	0.24	0.18	0.44	0.23	0.44	0.20	0.38	0.24	0.33	0.26	0.26	0.19	0.03	0.03		
PMCD160412	0.23	0.17	0.26	0.21	0.22	0.16	0.26	0.21	0.26	0.19	0.25	0.21	0.23	0.24	0.22	0.16	0.03	0.03		
PMC170312	0.25	0.20	0.30	0.20	0.20	0.17	0.30	0.20	0.30	0.19	0.28	0.20	0.25	0.18	0.21	0.17	0.03	0.03		
PMCD170312	0.20	0.17	0.20	0.17	0.19	0.15	0.21	0.17	0.19	0.17	0.20	0.17	0.20	0.16	0.19	0.16	0.03	0.03		
PMC170112	0.03	0.03	0.03	0.03	0.03	0.03	0.03	0.03	0.03	0.03	0.03	0.03	0.03	0.03	0.03	0.03	0.03	0.03	0.03	0.02
PMCD170112	0.03	0.03	0.03	0.03	0.03	0.03	0.03	0.03	0.03	0.03	0.03	0.03	0.03	0.03	0.03	0.03	0.03	0.03	0.03	0.02

PMC12 SERIES DIMENSIONS

COUPLING BODIES - Polypropylene

TERMINATION	TUBING/THREAD SIZE	METRIC EQ	STRAIGHT THRU	SHUTOFF	A	B
 IN-LINE PIPE THREAD	1/8" NPT		PMC100212	PMCD100212	0.88 (22.4)	1 (25.4)
	1/8" BSPT		PMC100212BSPT	PMCD100212BSPT	0.88 (22.4)	1 (25.4)
	1/4" NPT		PMC100412	PMCD100412	0.88 (22.4)	1.1 (27.9)
	1/4" BSPT		PMC100412BSPT	PMCD100412BSPT	0.88 (22.4)	1.1 (27.9)
 PANEL MOUNT FERRULELESS POLYTUBE FITTING, PTF†	1/4" OD, 0.17" ID	6.4mm OD, 4.3mm ID	PMC120412	PMCD120412	0.79 (20.1)	1.72 (43.7)
 PANEL MOUNT HOSE BARB	1/16" ID	1.6mm ID	PMC160112	PMCD160112	0.88 (22.4)	1.4 (35.6)
	1/8" ID	3.2mm ID	PMC160212	PMCD160212	0.88 (22.4)	1.65 (41.9)
	1/4" ID	6.4mm ID	PMC160412	PMCD160412	0.88 (22.4)	1.85 (47.0)
 IN-LINE FERRULELESS POLYTUBE FITTING, PTF†	1/4" OD, 0.17" ID	6.4mm OD, 4.3mm ID		PMCD130412	0.89 (22.6)	1.74 (44.2)
 IN-LINE HOSE BARB	1/16" ID	1.6mm ID	PMC170112	PMCD170112	0.89 (22.6)	1.42 (36.1)
	1/8" ID	3.2mm ID	PMC170212	PMCD170212	0.89 (22.6)	1.67 (42.4)
	1/4" ID	6.4mm ID	PMC170412	PMCD170412	0.89 (22.6)	1.87 (47.5)

PMC12 1/4-28 COUPLING BODIES - Polypropylene

TERMINATION	SHUTOFF	A	B
 TERMINATION PANEL MOUNT WITH A 1/4-28 FLAT BOTTOM PORT	PMCD18042812	0.88 (22.4)	1.57 (39.9)
 IN-LINE WITH A 1/4-28 FLAT BOTTOM PORT	PMCD19042812	0.89 (22.6)	1.57 (39.9)

All measurements are in inches (millimeters) unless otherwise noted. Tubing must meet stated inside and outside diameters. Couplings are pictured with valves unless otherwise noted.
 †NOTE: CPC's Ferruleless PTF (polytube fitting) terminations do not require ferrules to achieve a secure connection and are therefore easier to use and reuse. PTF fittings are designed for semi-rigid tubing, i.e., polyethylene, nylon, polyurethane, etc.

PRODUCT DIMENSIONS

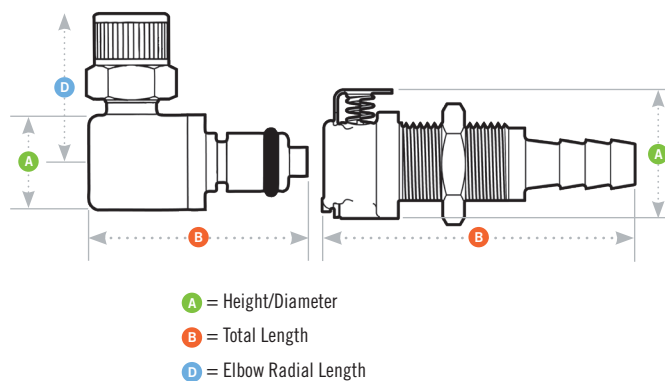





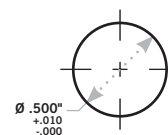

PANEL DIMENSIONS

	PANEL OPENING	PANEL THICKNESS MAX. - MIN.	PANEL NUT HEX	PANEL NUT THREAD
COUPLING BODIES	see drawing	0.50 - 0.05	5/8	1/2-24UNS
COUPLING INSERTS	see drawing	0.30 - 0.06	5/8	1/2-24UNS



COUPLING INSERTS - Polypropylene

TERMINATION	TUBING/THREAD SIZE	METRIC EQ	STRAIGHT THRU	SHUTOFF	A	B	D
 IN-LINE PIPE THREAD	1/8" NPT		PMC240212	PMCD240212	0.58 (14.7)	1.03/1.45 (26.16/36.83)	
 PANEL MOUNT IN-LINE HOSE BARB	1/16" ID	3.2mm ID	PMC420212	PMCD420212	0.72 (18.3)	1.74/1.82 (44.2/46.2)	
	1/8" ID	1.6mm ID		PMCD420112	0.72 (18.3)	1.57 (39.9)	
	1/4" ID	6.4mm ID		PMCD420412	0.72 (18.3)	2.04 (51.8)	
	1/4" ID	6.4mm ID		PMCD400412	0.72 (18.3)	1.81 (46.0)	
 IN-LINE FERRULELESS POLYTUBE FITTING, PTF†	1/4" OD, 0.17" ID	6.4mm OD, 4.3mm ID	PMC200412	PMCD200412	0.58 (14.7)	1.15/1.58 (29.2/40.1)	
 IN-LINE HOSE BARB (NON-VALVED SHOWN)	1/16" ID	1.6mm ID	PMC220112	PMCD220112	0.5 (12.7)	0.80/1.47 (20.3/37.3)	
	1/8" ID	3.2mm ID	PMC220212	PMCD220212	0.5 (12.7)	1.05/1.67 (26.7/42.4)	
	1/4" ID	6.4mm ID	PMC220412	PMCD220412	0.5 (12.7)	1.20/1.71 (30.5/43.4)	
 IN-LINE STRAIGHT THREAD PORT SAE	5/16 SAE-5		PMC24082012	PMCD24082012	0.72 (18.3)	1.05/1.15 (26.7/29.2)	
 ELBOW FERRULELESS POLYTUBE FITTING, PTF†	5/32" OD, 0.10" ID	4.0mm OD, 2.5mm ID	PMC2102512	PMCD2102512	0.5 (12.7)	1.09/1.21 (27.7/30.7)	0.77 (19.6)
	1/4" OD, 0.17" ID	6.4mm OD, 4.3mm ID	PMC210412	PMCD210412	0.5 (12.7)	1.17/1.21 (29.7/30.7)	0.77 (19.6)
 ELBOW HOSE BARB	1/8" ID	3.2mm ID	PMC230212	PMCD230212	0.5 (12.7)	1.09/1.21 (27.7/30.7)	0.69 (17.5)
	1/4" ID	6.4mm ID	PMC230412	PMCD230412	0.5 (12.7)	1.09/1.21 (27.7/30.7)	0.9 (22.8)

PMC12 1/4-28 COUPLING INSERTS - Polypropylene

TERMINATION	STRAIGHT THRU	SHUTOFF	A	B	D
 IN-LINE WITH 1/4-28 UNF THREADS	PMC24042812	PMCD24042812	0.50 (12.70)	1.5 37.6	
 PANEL MOUNT WITH A 1/4-28 FLAT BOTTOM PORT		PMCD48042812	0.72 (18.29)	1.6 39.4	

NUTS



TUBING SIZE	DESCRIPTION	PART NO.
1/16" and 1.8mm	1/4-28 Polypropylene Nut (natural)	2418900
1/8" and 3mm	1/4-28 Polypropylene Nut (natural)	2419000
1/16" and 1.8mm	1/4-28 Acetal Nut (black)	2419199
1/8" and 3mm	1/4-28 Acetal Nut (black)	2419299

FERRULES



TUBING SIZE	DESCRIPTION	PART NO.
1/16"	Ferrule, ETFE (blue)	2419300
1/8"	Ferrule, ETFE (yellow)	2419400
1.8mm	Ferrule, ETFE (green)	2419500
3.0mm	Ferrule, ETFE (orange)	2419600

All measurements are in inches (millimeters) unless otherwise noted. Tubing must meet stated inside and outside diameters. Couplings are pictured with valves unless otherwise noted.

†NOTE: CPC's Ferruleless PTF (polytube fitting) terminations do not require ferrules to achieve a secure connection and are therefore easier to use and reuse. PTF fittings are designed for semi-rigid tubing, i.e., polyethylene, nylon, polyurethane, etc.