

# PLC12 SERIES CONNECTOR

The 1/4" flow polypropylene PLC12 offers many of the same configuration options as the PLC. The polypropylene material adds greater chemical resistance for more demanding applications. PLC12 couplings are also gamma sterilizable. PLC12 couplings are also gamma sterilizable and available with optional RFID (Radio Frequency Identification) capability (see page 118).



## SPECIFICATIONS

### PPRESSURE:

Vacuum to 120 psi, 8.3 bar

### TEMPERATURE:

32°F to 160°F (0°C to 71°C)

### MATERIALS:

**Main components and valves:**  
Polypropylene

**Thumb latch:** Stainless steel

**Valve spring:** 316 stainless steel

**External springs and pin:** Stainless steel

**O-rings:** EPDM

### STERILIZATION:

**Gamma:** Up to 50 kGy irradiation

### COLOR:

Almond

### TUBING SIZES:

1/4" to 3/8" ID, 6.4mm to 9.5mm ID

*WARNING: Pressure, temperature, chemicals, and operating environment can affect the performance of couplings. It is the customer's responsibility to test the suitability of CPC's products in their own application conditions. Use the graph at the right as a guide.*



[cpcworldwide.com/PLC12](http://cpcworldwide.com/PLC12)

### FEATURES

- Polypropylene material → Chemically resistant and gamma sterilizable
- EPDM o-rings → Greater chemical resistance
- CPC thumb latch → One-hand connection and disconnection
- Integral terminations → Fewer leak points, shorter assemblies, faster installations

### BENEFITS



## DID YOU KNOW

PLC12 Couplings are gamma sterilizable; see page 168 for more information on sterilization and disinfection.

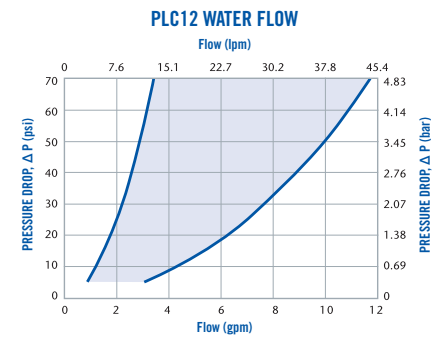
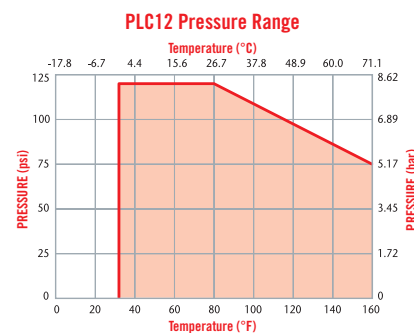
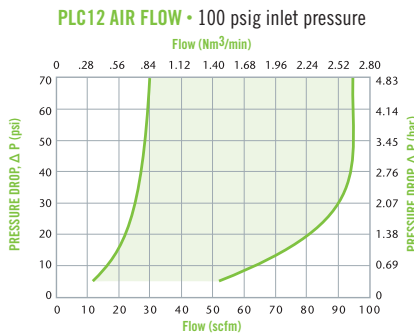

*These graphs are intended to give you a general idea of the performance capabilities of each product line. The shaded area of each graph represents the operating range of the product family, i.e., upper and lower values are shown. Therefore, depending on the exact coupling configurations selected, you can reasonably expect values to fall within the shaded area.*



## WHEN TO CONSIDER A CUSTOM PROJECT:

- A quick disconnect will add value to product, make it easier to use and more reliable
- Your specification cannot be met by an existing standard CPC product
- Unique requirements, budgets or timing warrant a conversation with CPC

### LIQUID FLOW RATE INFORMATION FOR COUPLINGS

The chart below shows the flow rate for CPC couplings. Each coupling was tested with water at 70°F (21°C). To determine flow rates for specific coupling configurations use the formula to the right.

$$Q = C_v \sqrt{\frac{\Delta P}{S}}$$

Q = Flow rate in gallons per minute  
 C<sub>v</sub> = Average coefficient across various flow rates (see chart)  
 ΔP = Pressure drop across coupling (psi)  
 S = Specific gravity of liquid





#### C<sub>v</sub> VALUES

#### INSERTS

	PLC 2000412	PLCD 2000412	PLC 2000612	PLCD 2000612	PLC 2200412	PLCD 2200412	PLC 2200612	PLCD 2200612	PLC 2400412	PLCD 2400412	PLC 2400612	PLCD 2400612	PLC 2600412
<b>BODIES</b>													
PLC1000412	0.40	0.36	1.05	0.58	0.83	0.56	1.40	0.82	1.40	0.75	1.40	0.77	0.83
PLCD1000412	0.36	0.31	0.73	0.48	0.66	0.41	0.82	0.50	.80	0.45	0.77	0.45	0.81
PLC1000612	0.40	0.36	1.05	0.60	0.83	0.56	1.40	0.81	1.40	0.76	1.40	0.76	0.83
PLCD1000612	0.37	0.31	0.81	0.47	0.70	0.43	1.02	0.51	0.98	0.46	0.99	0.48	0.98
PLC1200612	0.38	0.36	0.84	0.63	0.74	0.56	1.14	0.75	1.14	0.70	1.14	0.72	0.74
PLCD1200612	0.38	0.33	0.78	0.49	0.68	0.44	0.84	0.49	0.81	0.43	0.82	0.44	0.81
PLC1600412	0.38	0.37	0.87	0.54	0.95	0.51	1.00	0.70	0.95	0.64	1.00	0.66	0.95
PLCD1600412	0.37	0.31	0.61	0.44	0.57	0.41	0.78	0.44	0.78	0.43	0.75	0.46	0.78
PLC1600612	0.38	0.37	1.00	0.57	0.95	0.53	1.40	0.80	1.40	0.71	1.40	0.73	1.40
PLCD1600612	0.38	0.32	0.71	0.49	0.63	0.42	0.89	0.51	0.96	0.45	0.92	0.49	0.97

# PLC12 SERIES DIMENSIONS

## COUPLING BODIES - Polypropylene

	TERMINATION	TUBING/THREAD SIZE	METRIC EQ	STRAIGHT THRU	SHUTOFF	A	B
	IN-LINE PIPE THREAD	1/4" NPT		PLC1000412	PLCD1000412	1 (25.4)	1.15 (29.2)
		1/4" BSPT		PLC1000412BSPT	PLCD1000412BSPT	1 (25.4)	1.15 (29.2)
		3/8" NPT		PLC1000612	PLCD1000612	1 (25.4)	1.15 (29.2)
		3/8" BSPT		PLC1000612BSPT	PLCD1000612BSPT	1 (25.4)	1.15 (29.2)
	PANEL MOUNT FERRULELESS POLYTUBE FITTING, PTF†	3/8" OD, 1/4" ID	9.5mm OD, 6.4mm ID	PLC1200612	PLCD1200612	1 (25.4)	1.95 (49.5)
	PANEL MOUNT HOSE BARB	1/4" ID	6.4mm ID	PLC1600412	PLCD1600412	1 (25.4)	1.95 (49.5)
		3/8" ID	9.5mm ID	PLC1600612	PLCD1600612	1 (25.4)	1.95 (49.5)
	IN-LINE FERRULELESS POLYTUBE FITTING, PTF†	3/8" OD, 1/4" ID	9.5mm OD, 6.4mm ID	PLC1300612	PLCD1300612	1.02 (25.9)	1.96 (49.8)
	IN-LINE HOSE BARB	1/4" ID	6.4mm ID	PLC1700412	PLCD1700412	1.02 (25.9)	1.96 (49.8)
		3/8" ID	9.5mm ID	PLC1700612	PLCD1700612	1.02 (25.9)	1.96 (49.8)

## COUPLING READERS - Polypropylene

	TERMINATION	TUBING/THREAD SIZE	METRIC EQ	STRAIGHT THRU	SHUTOFF	A	B
	IN-LINE HOSE BARB (RS-232 INTERFACE)	1/4" ID	6.4mm ID		iPLCDR1700400	1.39 (35.3)	2.78 (70.6)
		3/8" ID	9.5mm ID		iPLCDR1700600	1.39 (35.3)	2.78 (70.6)
	IN-LINE HOSE BARB (USB INTERFACE)	3/8" ID	9.5mm ID		iPLCDR1700601	1.05 (26.7)	1.74/1.87 (44.2/47.5)

All measurements are in inches (millimeters) unless otherwise noted. Tubing must meet stated inside and outside diameters. †NOTE: CPC's Ferruleless Polytube Fitting terminations do not require ferrules to achieve a secure connection, which makes them easier to use and reuse. PTF fittings are designed for semi-rigid tubing, i.e., polyethylene, nylon, polyurethane, etc. NOTE: JG is a registered trademark of John Guest USA, Inc.

### PRODUCT DIMENSIONS

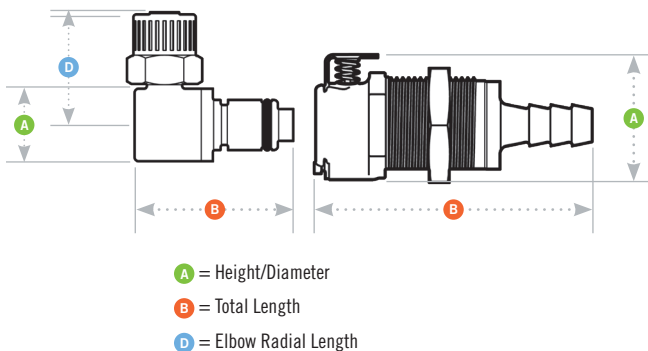





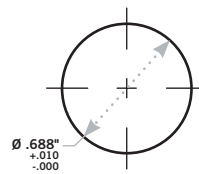



### PANEL DIMENSIONS

	PANEL OPENING	PANEL THICKNESS MAX.-MIN.	PANEL NUT HEX	PANEL NUT THREAD
COUPLING BODIES	see drawing	0.30 - 0.02	13/16	11/16-24UNEF
COUPLING INSERTS	see drawing	0.30 - 0.02	13/16	11/16-24UNEF



## COUPLING INSERTS - Acetal

	TERMINATION	TUBING/THREAD SIZE	METRIC EQ	STRAIGHT THRU	SHUTOFF	A	B	D
	<b>IN-LINE PIPE THREAD</b>	1/4" NPT		PLC2400412	PLCD2400412	0.72 (18.3)	1.26/1.67 (32.0/42.4)	
	<b>PANEL MOUNT HOSE BARB</b>	1/4" ID	6.4mm ID	PLC4200412	PLCD4200412	0.94 (23.9)	1.91/2.05 (48.5/52.1)	
		3/8" ID	9.5mm ID	PLC4200612	PLCD4200612	0.94 (23.9)	1.91/2.05 (48.5/52.1)	
	<b>IN-LINE FERRULELESS POLYTUBE FITTING, PTF†</b>	3/8" OD, 1/4" ID	9.5mm OD, 6.4mm ID	PLC2000612	PLCD2000612	0.72 (18.3)	1.68/1.82 942.7/46.2)	
		-	8.0mm ID		PLCD200M812	0.72 (18.3)	1.82 (46.2)	
	<b>IN-LINE HOSE BARB</b>	1/4" ID	6.4mm ID	PLC2200412	PLCD2200412	0.63 (16.0)	1.35/2.00 (34.3/50.8)	
		3/8" ID	9.5mm ID	PLC2200612	PLCD2200612	0.63 (16.0)	1.35/1.82 (34.3/46.2)	
	<b>ELBOW FERRULELESS POLYTUBE FITTING, PTF†</b>	3/8" OD, 1/4" ID	9.5mm OD, 6.4mm ID	PLC2100612	PLCD2100612	0.61/0.62 (15.5/15.8)	1.29/1.36 (32.8/34.5)	0.96 (24.4)
	<b>ELBOW HOSE BARB</b>	(RS-232 Interface)	6.4mm ID	PLC2300412	PLCD2300412	0.63 (16.0)	1.22/1.36 (31.0/34.5)	0.96 (24.4)
			9.5mm ID	PLC2300612	PLCD2300612	0.63 (16.0)	1.28/1.42 (32.5/36.1)	0.96 (24.4)
		3/8" ID						
	<b>IN-LINE HOSE BARB</b>	1/4" ID	6.4mm ID	iPLCT2200400	iPLCDT2200400	1.39 (35.3)	2.78 (70.6)	
	<b>ELBOW HOSE BARB (RS-232 INTERFACE)</b>	1/4" ID	6.4mm ID		iPLCDT2300400	1.48 (37.6)	1.27/1.40 (32.3/35.6)	
		3/8" ID	9.5mm ID		iPLCDT2300600	1.48 (37.6)	1.33/1.46 (33.8/37.1)	

All measurements are in inches (millimeters) unless otherwise noted. Tubing must meet stated inside and outside diameters. Couplings are pictured with valves unless otherwise noted.

†NOTE: CPC's Ferruleless Polytube Fitting terminations do not require ferrules to achieve a secure connection, which makes them easier to use and reuse. PTF fittings are designed for semi-rigid tubing, i.e., polyethylene, nylon, polyurethane, etc. NOTE: JG is a registered trademark of John Guest USA, Inc.